

**Nu Victorian Urn Large Face Fix**

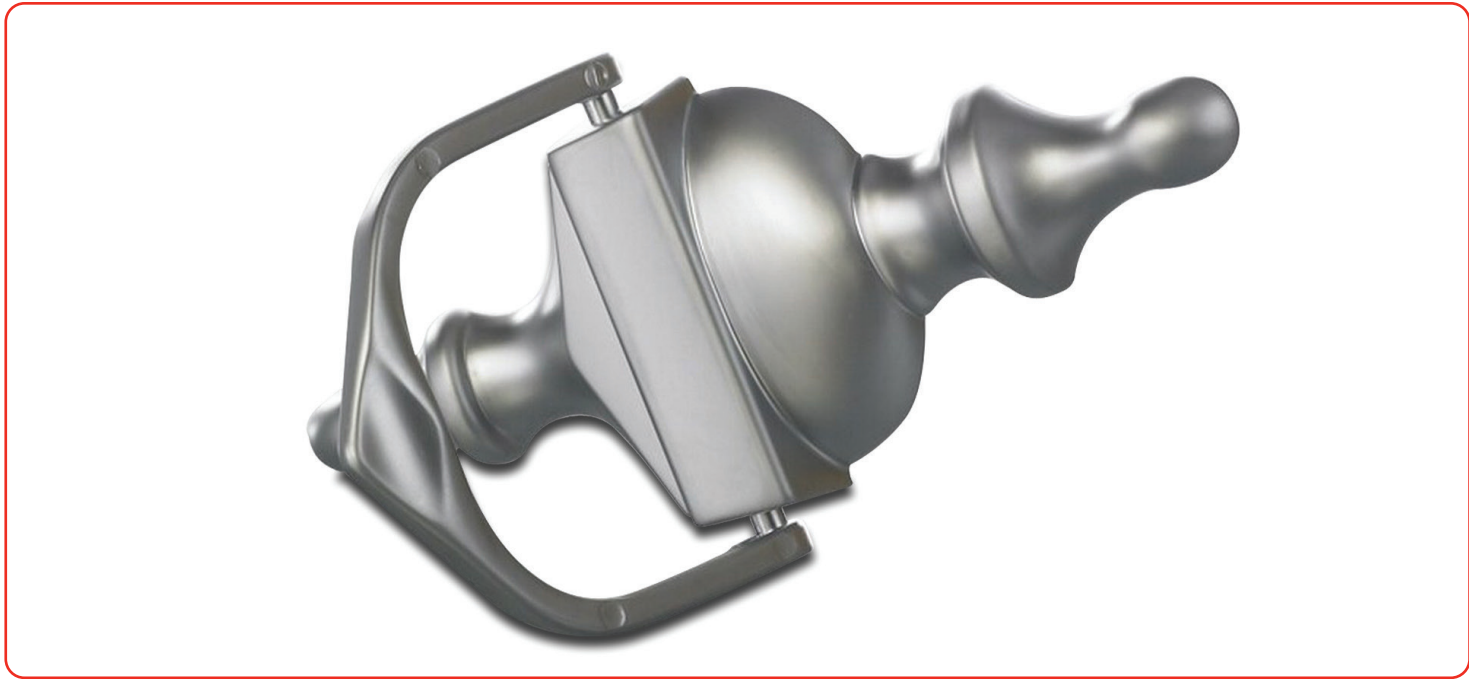

**Features**

- **Large 8" door knocker**  
Striking finish to any door
- **Patented face fixing plate works with all major door materials**  
Easy installation; no need to use fixing bolts or to drill through the door (unless using optional viewer)
- **Available with or without door viewer aperture**  
Options to neatly conceal the door viewer
- **Wide range of viewers and extensions available**  
Cater for all major door depths
- **Classic door knocker design**  
Create an elegant and stylish front door

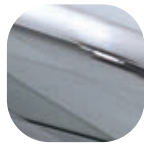

Hardex Chrome

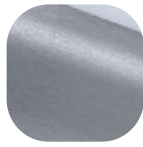

Hardex Graphite



White



Hardex Bronze

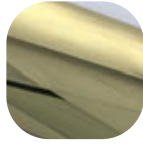

Hardex Gold



Black



Premium Satin

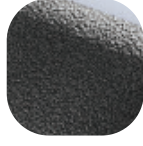

Antique Black



Silver

## Nu Victorian Urn Large Face Fix

### Ordering Details

Product	Part No.	
<b>Nu Victorian Urn Large Face Fix</b>		
Finish	Without Spyhole	With Spyhole
Hardex Chrome	4A204	4A254
Hardex Bronze	4A206	4A256
Hardex Gold	4A208	4A258
Hardex Graphite	4A211	4A261
Antique Black	4A209	4A259
White	4A200	4A250
Black	4A201	4A251
Silver	4A202	4A252
Premium Satin	DFNKNLUPS	DFNKNLUPPS

### Technical Information

#### Corrosion resistance

Meets the requirements of BS EN 1670 Grade 5 (480 hours)

#### Material Specification

Knocker:	High quality Zinc
Coatings:	Hardex Chrome, Hardex Bronze, Hardex Gold, Hardex Graphite, Antique Black, Premium Satin, White, Black and Silver.

### Maintenance

For continued protection of the quality finish and appearance, we advise routine cleaning of all our external hardware. We recommend wiping it with a clean cloth soaked in warm water and mild detergent every month. Please refrain from using heavy-duty cleaners, containing Chlorine or Potassium. Moving parts should also be lightly lubricated using a light non-acidic mineral oil (e.g., "3 in 1") at least twice per year. The product may need to be adjusted and fixings tightened to ensure a satisfactory operation. This procedure is particularly essential if products are used within a 25-mile radius of coastal areas or close proximity to building sites or large industrial areas, where more frequent cleaning may be required to prevent the accumulation of corrosive contaminants.

### Packaging

#### Urn Knocker

Individually boxed with fixings and care instructions.  
20 knockers in an outer box.

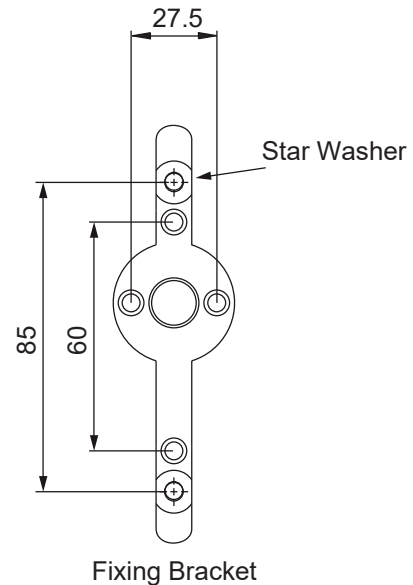
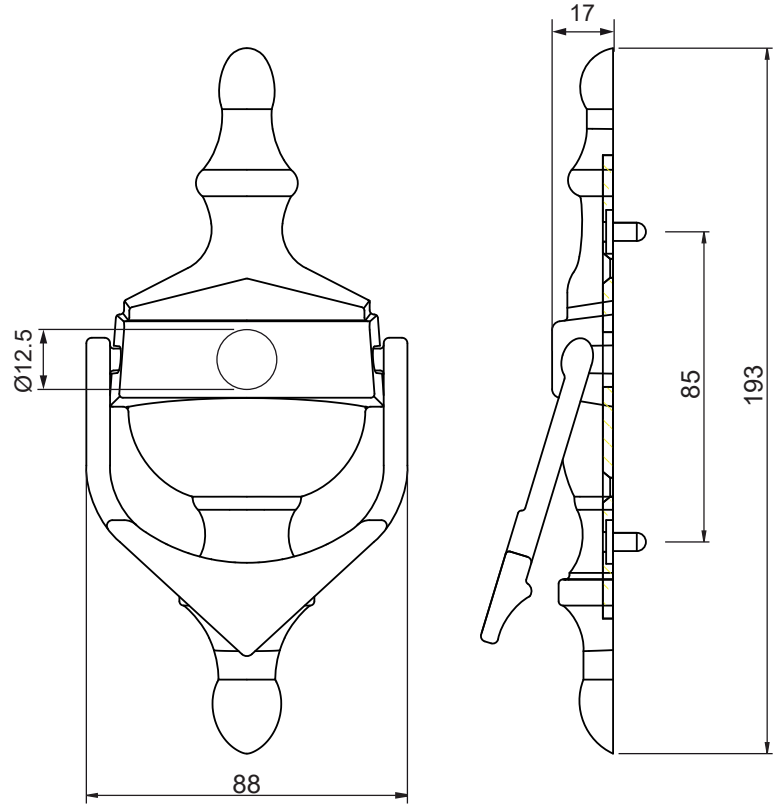

All dimensions are in mm and are nominal.  
Fab&Fix reserves the right to change specification without notice.  
It is the responsibility of the door manufacturer to ensure that the finished product meets any required safety and performance specification.